

REAR ELEVATION

1/4" = 1'-0"

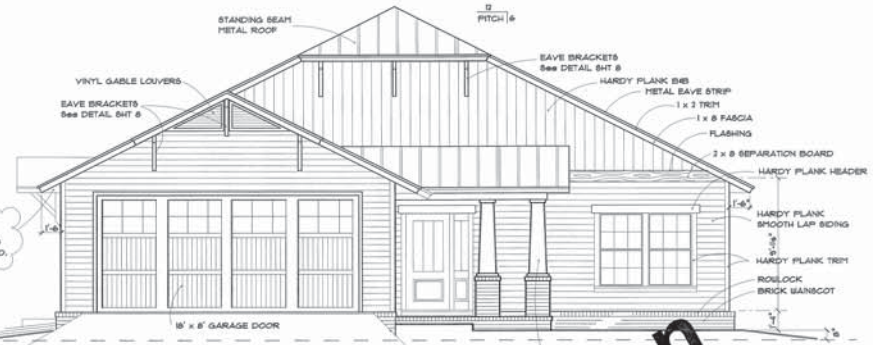

FRONT ELEVATION

1/4" = 1'-0"

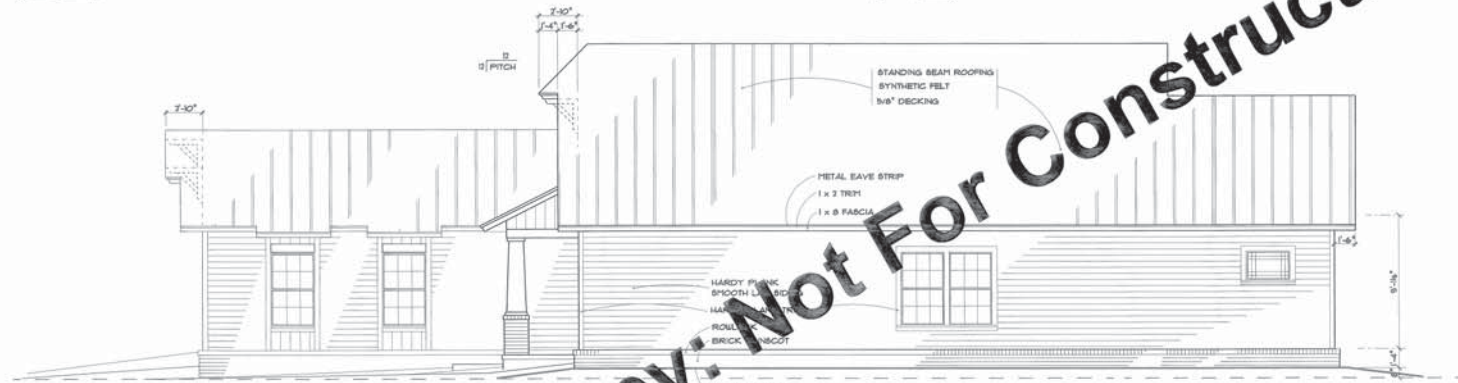

RIGHT SIDE

1/4" = 1'-0"

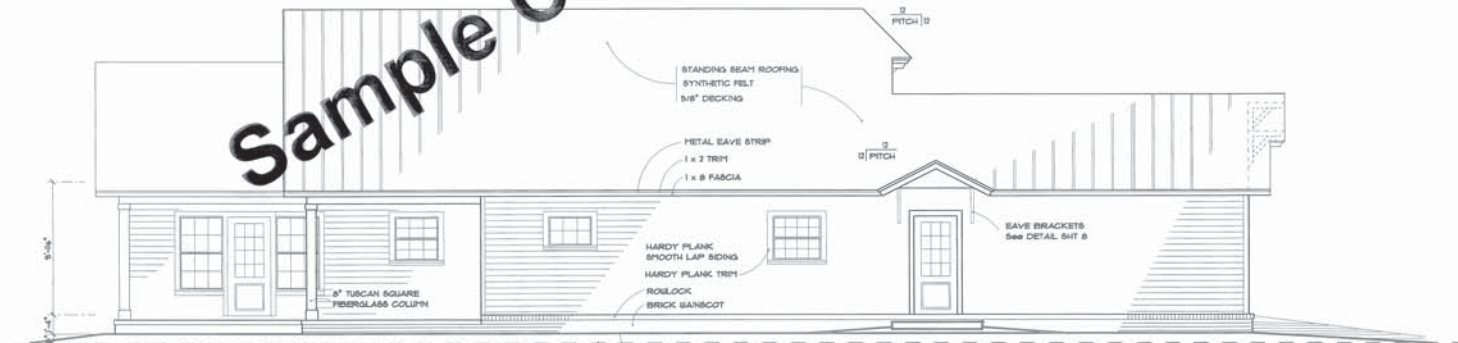

RIGHT SIDE

1/4" = 1'-0"

Sample Copy: Not For Construction

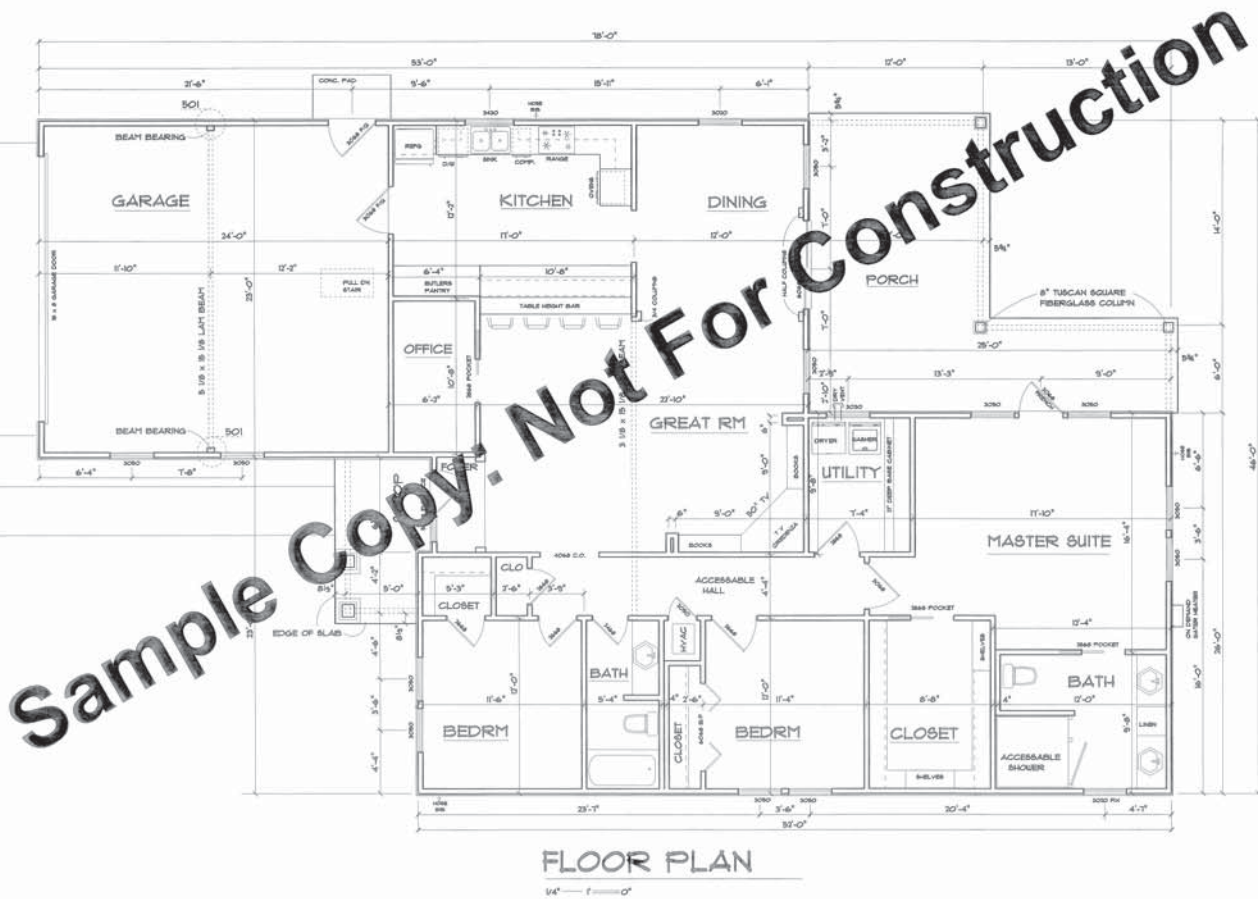

1931 Sq. Ft. Heated
930 Sq. Ft. Other
2861 Sq. Ft. Total

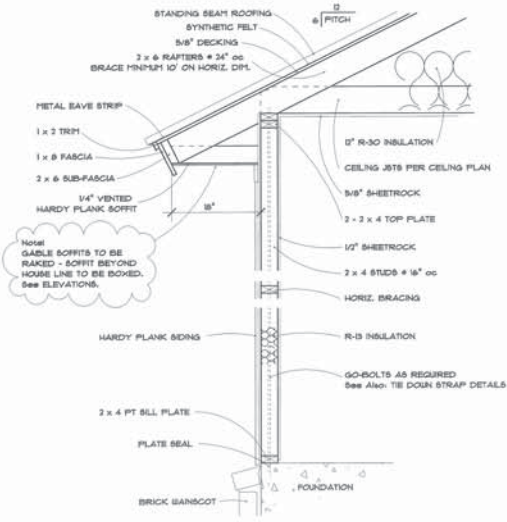

WALL SECTION

TIE DOWN -
RAFTER TO STUD

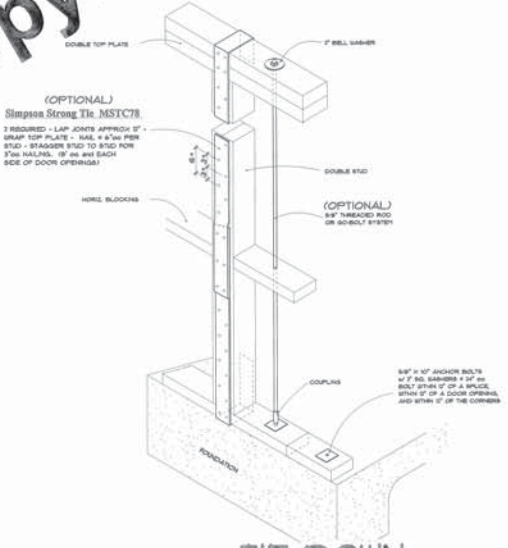
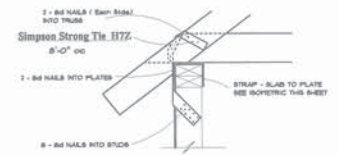

TIE DOWN -
SLAB TO PLATE

(ISOMETRIC)

USE OPTIONAL STRAP OR ROD OR A COMBINATION OF BOTH PER BEST APPLICATION

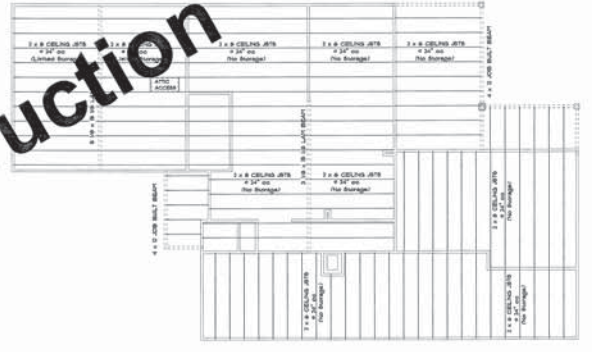

CEILING FRAMING

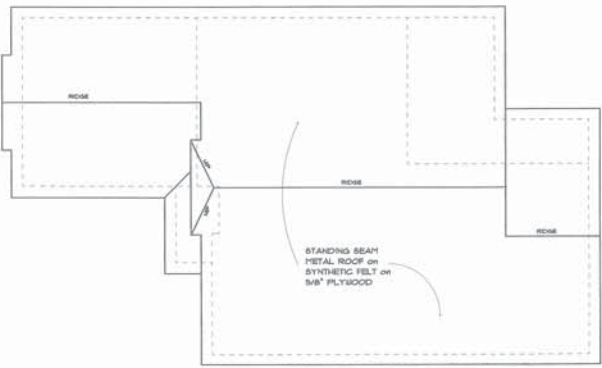

ROOF PLAN

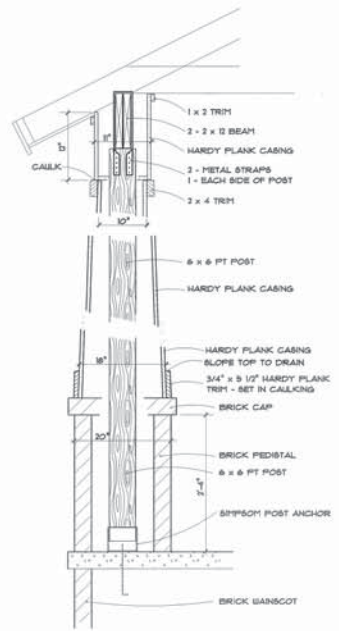

FRONT PORCH COLUMN
1" = 1'-0"

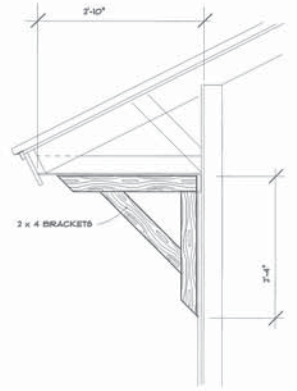

EAVE BRACKETS
1" = 1'-0"

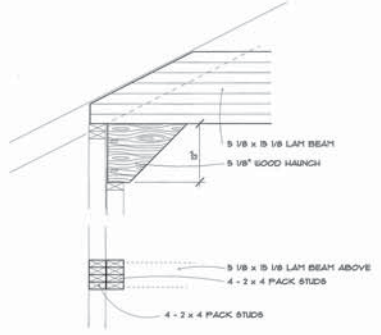

BEAM BEARING 501
1" = 1'-0"

Sample Copy: Not For Construction



KITCHEN

NOTE:
ALL BASE CABINET SHELVES SHALL BE ROLL OUT.
FIELDWORK CONTRACTOR VERIFY ALL APPLIANCES
WITH OWNER PER SIZE AND INSTALLATION.

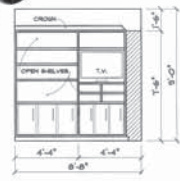

T.V. CREDEZZA
VERIFY ALL ASPECTS W/ OWNER

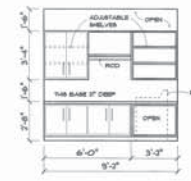

UTILITY ROOM



MASTER BATH



BATH 2

MILLWORK
1/4" = 1'-0"

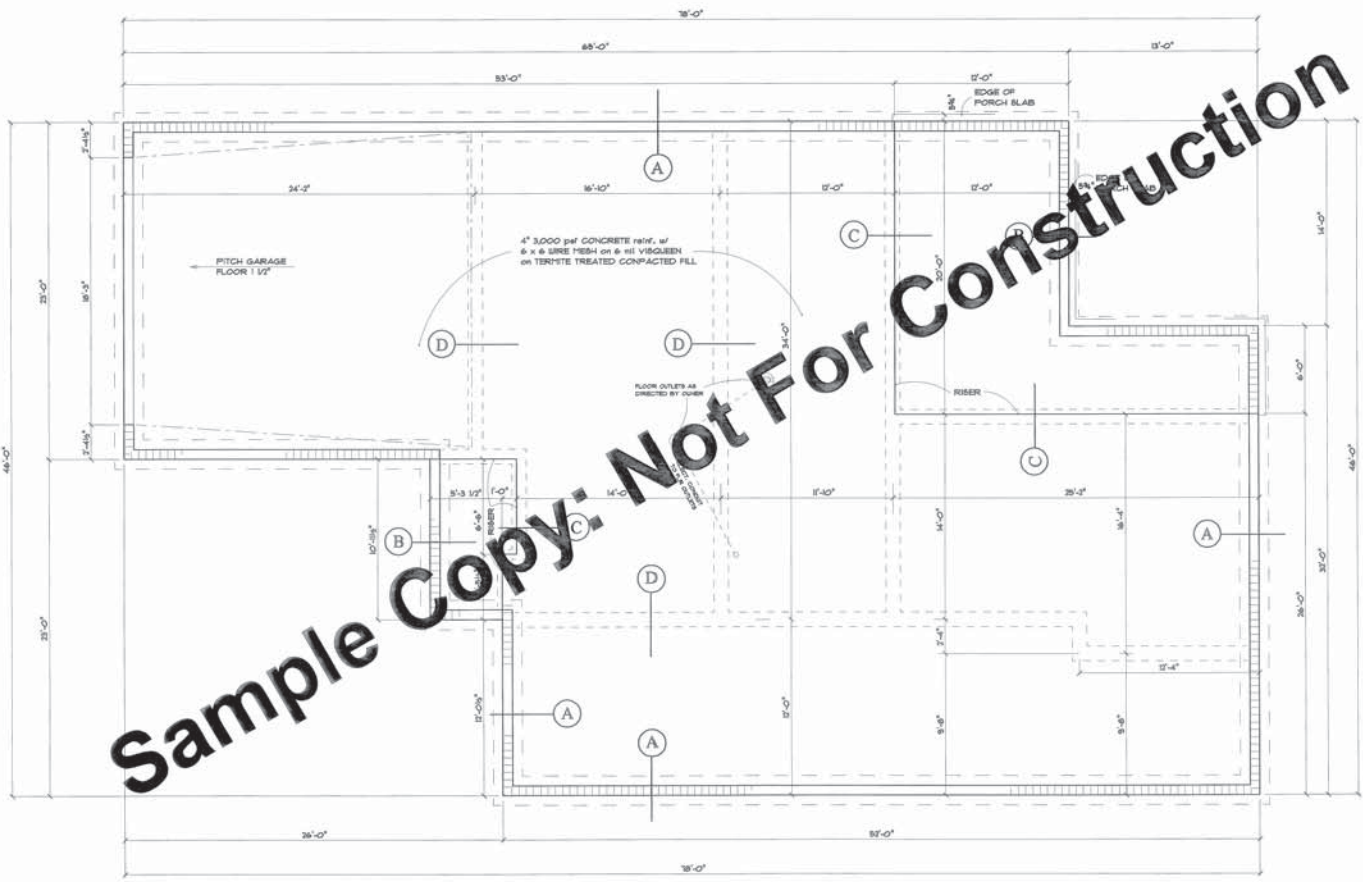
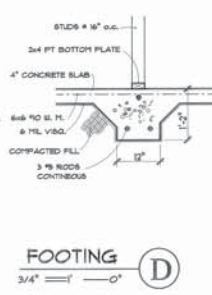
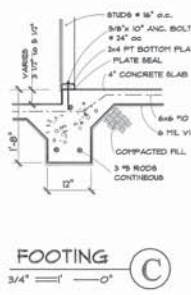
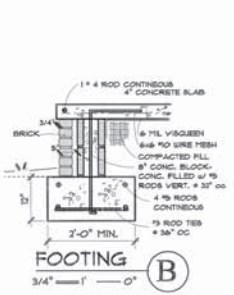
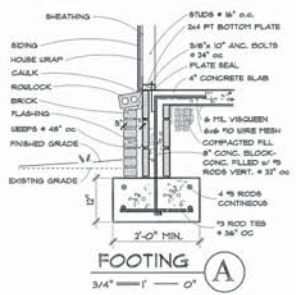

Sample Copy: Not For Construction

FOUNDATION PLAN
1/4" = 1" = 0"

© Copyright 2013

Sample Copy: Not For Construction

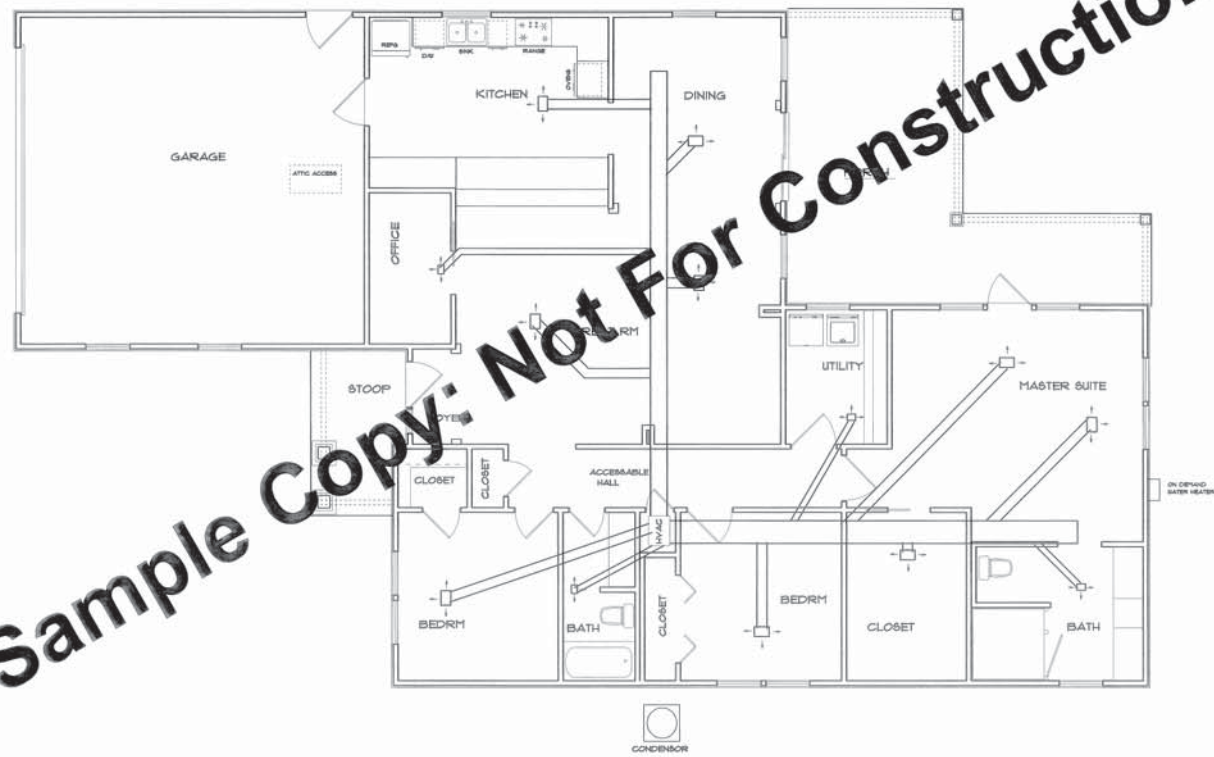

MECHANICAL PLAN

1/4" = 1'-0"

THIS PLAN IS SCHEMATIC ONLY. THE MECHANICAL CONTRACTOR SHALL SIZE THE DUCT, DUCT AND DROP LOCATIONS FOR MAXIMUM EFFICIENCY AND ASSUME THE RESPONSIBILITY THEREOF.

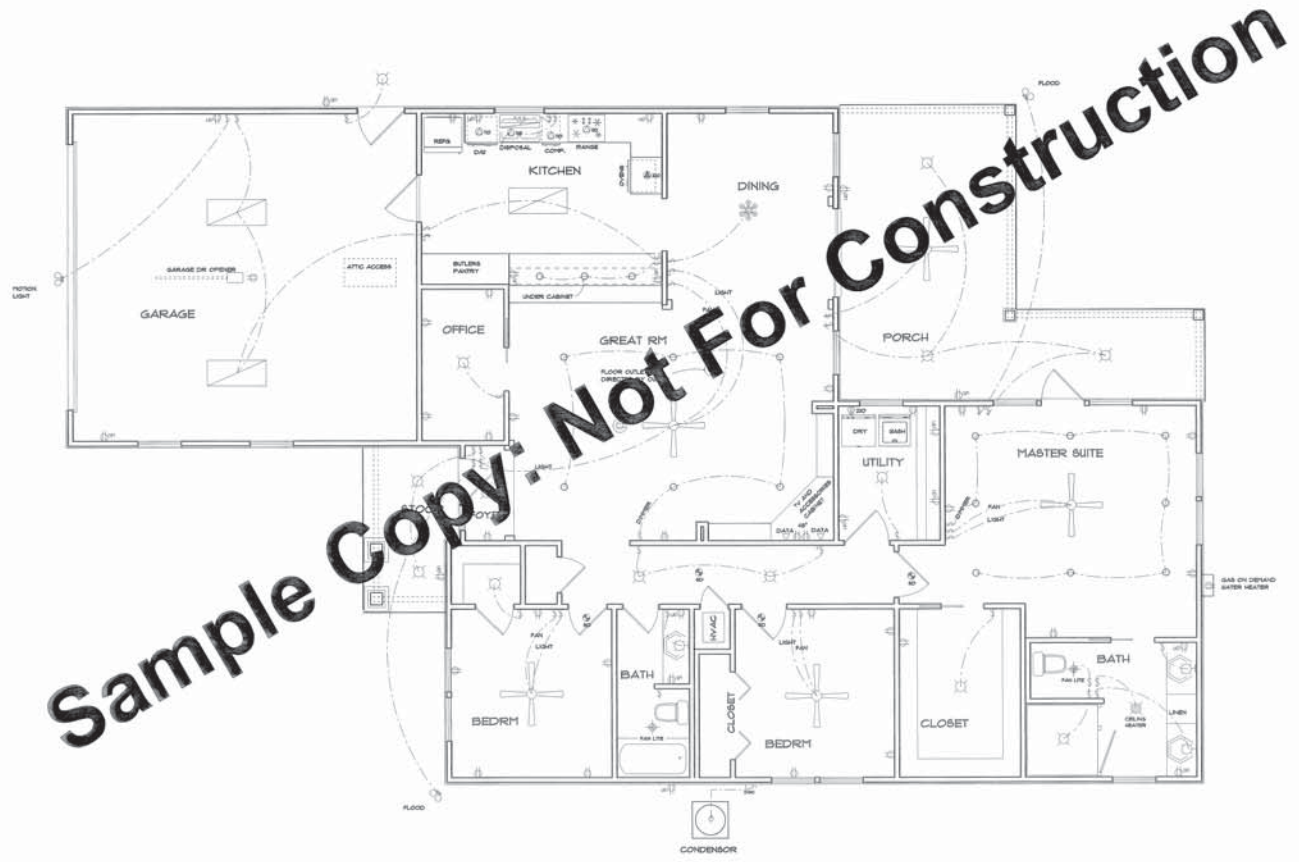

ELECTRICAL PLAN

1/4" = 1'-0"

TV AND DATA OUTLETS
AS DIRECTED BY OWNER